

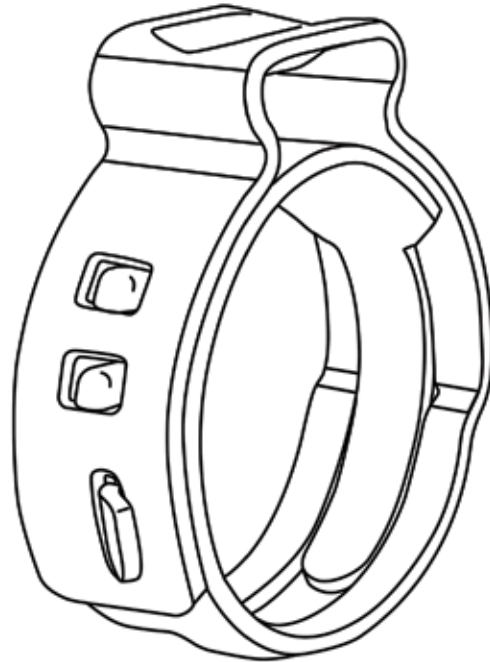

Reliable Connections



Standard and PEXGrip® Clamps
HIP 7000 Series Ratchet Pincers
HTC 500 Hand Tubing Cutters
HCC 2000 Hand Clamp Cutter

Clamp installation instructions
Tool calibration procedures
Hand tubing cutters guide
Clamp removal instructions

Original instruction manual
Issue November 2020

Item no. 08903660
OETIKER Marlette, MI

1 Information about this manual

1.1 Symbols and means of depiction

Safety notices are used in this manual to warn of the risk of personal injury or property damage.

- ▶ Always read and observe these safety notices.
- ▶ Observe all notices that are flagged with a safety alert symbol and text.

The following symbols are used in this instruction manual:

Symbol	Meaning
 WARNING	Failure to observe this notice may lead to property damage.
NOTICE	Information for proper use.
1. ... 2. ... 3. ...	Multi-step instructions ▶ Carry out the steps in the order shown.

1.2 Scope

This instruction manual is intended for Oetiker StepLess® Ear Clamps 167, manufactured to meet ASTM F2098 in both the Standard PEX Clamp and PEXGrip® Clamp variety for use in conjunction with:

- PEX or PE-RT Tube per ASTM F877
- PEX Insert fittings per ASTM F1807 or F2159
- PEX connecting solutions for markets compliant with Standard ASTM F877/F2098

The specified clamps are suitable for fast and secure connections for PEX tubing in the plumbing field. The clamp design is tamper evident.

2 Basic instructions

2.1 Recommended installation

The products may only be used for the intended purpose and under safe and fault-free conditions.

- Correct usage also covers observance of this instruction manual.
- Any use not in accordance with the prescribed usage shall be regarded as incorrect usage, and may lead to product failure.
- For proper installation of Oetiker PEX series clamps, use calibrated genuine Oetiker installation tools.
- For ratchet pincer maintenance, care and calibration, reference the complete Calibration Procedures supplied with tool or reference sections 3.1, 3.2 and 3.3 of this instruction manual.

1. **3-Handle Ratchet Pincer** (Fig. 1)
Oetiker HIP 7000 I 280
Item no. 14100280

- Includes GO/NO-GO gauge
- Can be calibrated
- Lightweight for easy handling
- Heavy-duty professional grade tool
- Single handed installation

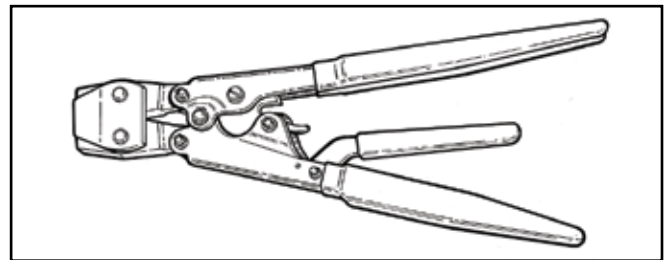

Fig. 1: Item no. 14100280

2. **2-Handle Ratchet Pincer** (Fig. 2)
Oetiker HIP 7000 I 069
Item no. 14100069

- Includes GO/NO-GO gauge
- Can be calibrated
- Lightweight for easy handling
- Heavy-duty professional grade tool

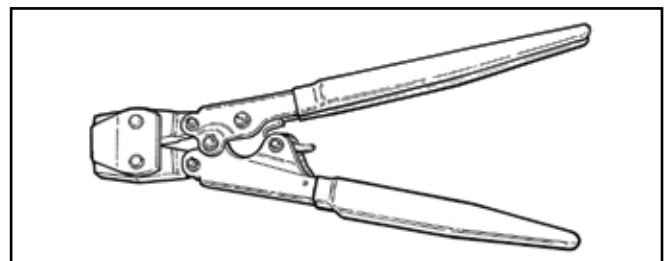

Fig. 2: Item no. 14100069

3. **DIY Economy 2-Handle Ratchet Pincer** (Fig. 3)
Oetiker HIP 7000 I 337
Item no. 14100337

- Includes NO-GO gauge pin
- Cannot be calibrated, tool is not adjustable
- Lightweight for easy handling
- Tool must be disposed of when out of calibration
- Light-duty tool

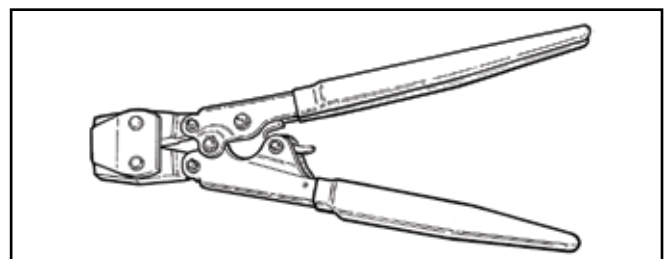

Fig. 3: Item no. 14100337

2.2 Clamp installation instructions

1. Per ASTM F2098, insert fitting into tubing until shoulder or tube stop contacts end of tubing. Position clamp within 1/8" to 1/4" (3.2 to 6.4 mm) of tube end. (Fig. 4)

! Note: "Tube end" must be cut square. (Reference section 4 of this instruction manual for Oetiker recommended Hand Tubing Cutters.)

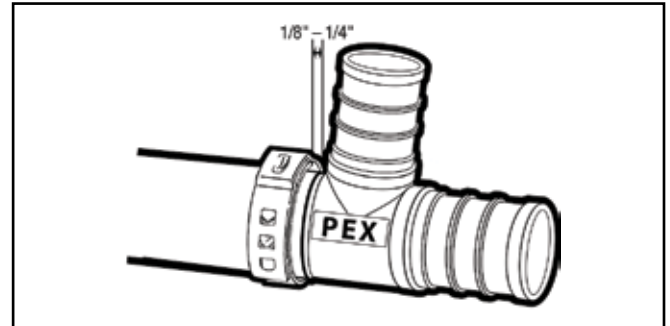

Fig. 4: Insert fitting/position clamp

2. Close clamp ear with tool, tool will not release until clamp is fully closed. (Fig. 5)

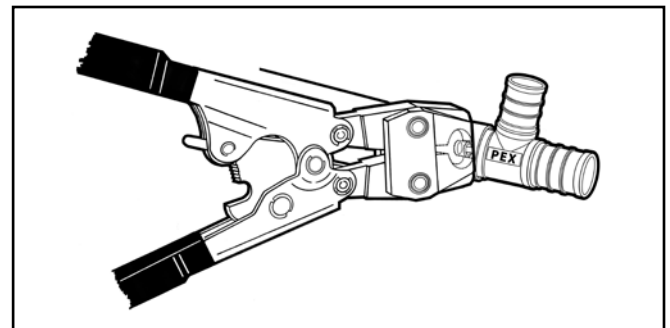

Fig. 5: Close clamp ear with tool

3. **IMPORTANT:** For proper installation of Oetiker PEX series clamps, full ear closure is required. Visually inspect clamp for correct closed ear form. (Fig. 6)

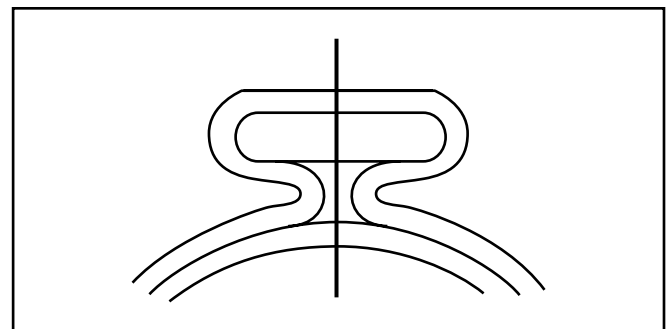

Fig. 6: Full ear closure required

2.2.1 Assembly notice

NOTICE

- ▶ For the correct assembly of Oetiker StepLess® 167 PEX clamps, the clamps must be completely closed.
- ▶ Genuine Oetiker Hand Installation Pincers with ratchet mechanism will release only when clamp has fully closed.
- ▶ Tool information for HIP 7000 Ratchet Pincer Series, for Oetiker PEX Clamps, can be found in section 2.1.

2.2.2 Warning notice: clamp installations

WARNING

- ▶ In high chloride water conditions, use only plastic fittings.
- ▶ Do not install in contact with concrete.
- ▶ Use only ASTM F1807 or F2159 insert fittings with OETIKER clamps.
- ▶ Failure to observe the above warnings may result in property damage.

2.2.3 International standards

- Clamps conform to ASTM¹ F2098 for use with ASTM F1807 and F2159 insert fittings and ASTM F876 PEX² tubing. For additional information, please refer to ASTM International Standards Worldwide.
- Complies with NSF³ product listing cNSFus-PW. For additional information, please refer to the NSF organization.

¹ ASTM = American Society for Testing and Materials

² PEX = Polyethylene cross-linked

³ NSF = National Sanitation Foundation

3 Ratchet pincer calibration prodcedures

3.1 Checking the tool calibration for: Item nos. 14100280 and 14100069

Calibration instructions on this page are specific for Ratchet Pincer Item nos. 14100280 and 14100069

1. Close handles of manual pincer to stop point (Fig. 7).

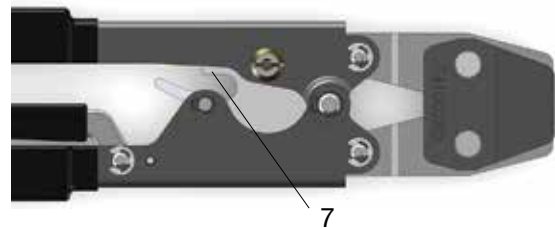

Fig. 7: Stop point

2. Insert GO/NO-GO Gauge into jaw gap (Fig. 8 and Fig. 9).

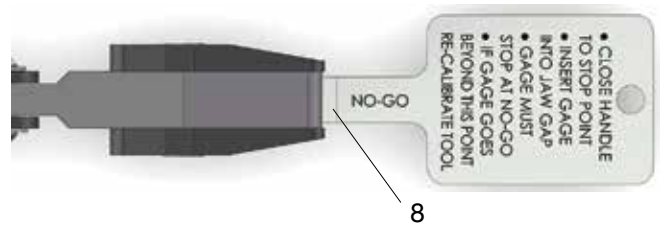

Fig. 8: Insert gauge

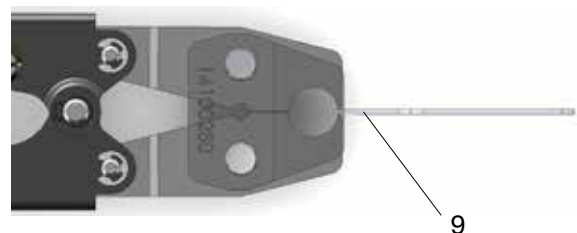

Fig. 9: Insert gauge (side view)

3. GO/NO-GO Gauge must stop at NO-GO shoulder.
4. If the gauge passes through the NO-GO point, the tool much be recalibrated (see section 3.3).
5. Check tool calibration daily.

Oetiker StepLess® Ear Clamps 167 for PEX

3.2 Checking the tool calibration for: Item no. 14100337

Calibration instructions on this page are specific for Ratchet Pincer Item no. 14100337

1. A NO-GO Gauge “Pin” (.062 dia.) is provided to determine if the tool is in calibration and is capable of providing crimps that conform to industry standards.
2. Grasp the handles and close the tool until the ratchet is released. Hold the handles in the closed position and attempt to insert the NO-GO Gauge “Pin” into the jaw tips.
3. If the “Pin” passes into the opening beyond the jaw tips (Fig. 10), the tool is no longer useable! It will not make crimps that conform to the specification and must be discarded.
4. Check tool calibration daily.

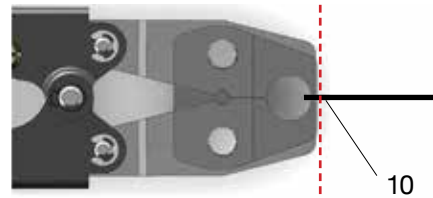

Fig. 10: NO-GO Gauge Pin “must not” pass jaw tips. Discard tool if NO-GO gauge pin passes.

3.2.1 Calibration and spare parts notice

NOTICE

- ▶ DIY Economy 2-Handle Ratchet Pincer (Item no. 14100337): tool is not adjustable, dispose of tool once it is out of calibration.
- ▶ No spare parts are available for the DIY Economy 2-Handle Ratchet Pincer (Item no. 14100337).

Oetiker StepLess® Ear Clamps 167 for PEX

3.3 Re-calibrating tools for: Item nos. 14100280 and 14100069

Re-calibration instructions on this page are specific for Ratchet Pincer Item nos. 14100280 and 14100069

1. Using a straight blade screw driver, loosen adjustment nut (Fig. 11).
2. Close handles to stop point and place GO/NO-GO Gauge into jaw gap.
3. Using a straight blade screwdriver, rotate eccentric stud (Fig. 12) counter-clockwise until jaws contact the GO/NO-GO Gauge before the NO-GO area of the Gauge.

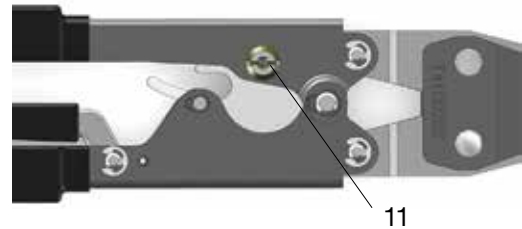

Fig. 11: Adjustment nut

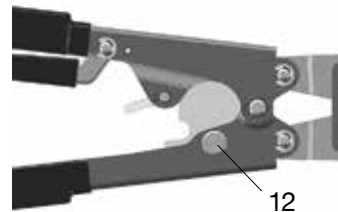

Fig. 12: Eccentric stud

4. Using a straight blade screwdriver, tighten the adjustment nut (Fig. 13).
5. Check tool calibration daily.

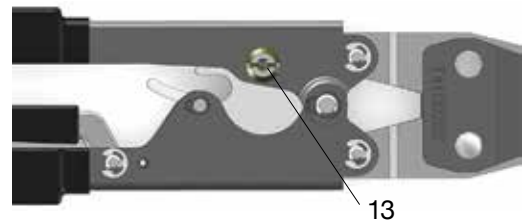

Fig. 13: Adjustment nut

3.4 Tool maintenance

- Do not use the Ratchet Tools for any purpose other than to assemble clamps. Use other than intended may damage the tool and void warranty.
- Lubricate the tool head, spring and ratchet mechanism once per every 30 days with a light lubricating oil (if tool operation becomes sluggish at any time lubricate prior to further use).
- Clean tool periodically to remove rust and dirt. Rust or dirt build-up will interfere with tool operation and void warranty coverage. Lubricate all parts after cleaning to provide a light protective coating of oil.

3.5 Tool warranty

When properly maintained and used as intended the Ratchet Tools are warranted against materials and manufacturing defects for a period of one year from date of purchase. This warranty does not cover defects or damage arising from improper storage or handling, ordinary wear and tear, misuse, abuse, accident or use with unauthorized product or parts. Liability is limited to repair or replacement of product or component part which is determined defective as covered by this warranty.

4 Hand tubing cutters for PEX: Item nos. 14100408 and 14100418

Recommended for cutting PEX tubing.

4.1 HTC 500 I 408 features and instruction guide

Hand Tubing Cutter (Fig. 14)

Oetiker HTC 500 I 408

Item no. 14100408

- Quickly cuts PEX tubing up to 3/4", PEX type A, B, & C
- V-shaped notch keeps pipe or tube steady
- Light and durable glass filled nylon construction
- Super sharp blade for quick and easy cuts



Fig. 14: Item no. 14100408

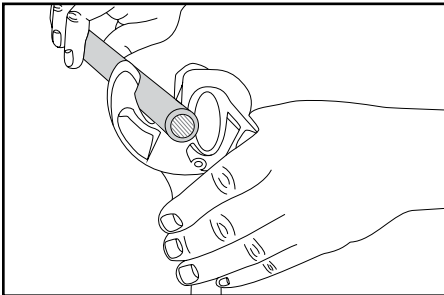

1. Place cutting chamber around tube

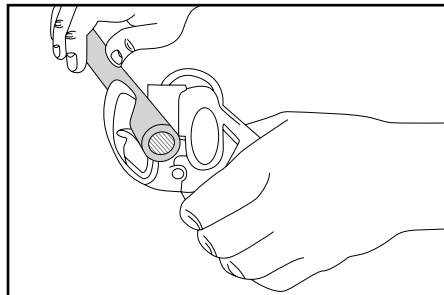

2. Squeeze handles

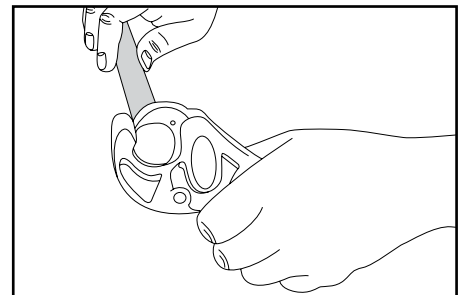

3. Remove tubing

4.2 HTC 500 I 418 features and instruction guide

Radial Hand Tubing Cutter (Fig. 15)

Oetiker HTC 500 I 418

Item no. 14100418

- For PEX tube, plastic conduit and gas pipe
- Cuts 1/2", 3/4" & 1" PEX tube, PEX type A, B & C
- Compact tool cuts tube square, keeps it round
- Straight, circular cuts form tighter connections



Fig. 15: Item no. 14100418

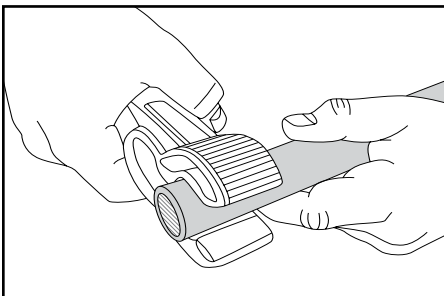

1. Push tubing into cutting chamber

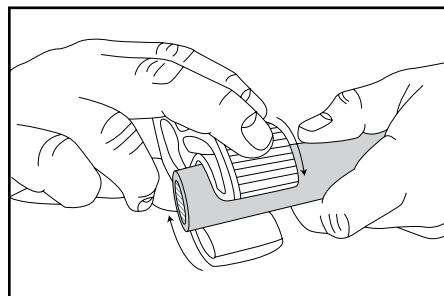

2. Rotate cutter in direction of arrow

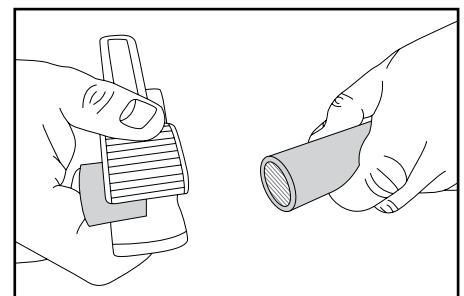

3. Squeeze handles and remove tubing

5 Hand clamp cutter for Oetiker ear clamps

Specially designed for removing Oetiker Ear Clamps, quick and easy ear clamp cutting.

Compound Action Hand Clamp Cutter (Fig. 16)
Oetiker HCC 2000 I 502
Item no. 14100502

5.1 Clamp removal instruction guide

1. Place hand clamp cutter jaw tips on each side of clamp ear or single leg (Fig. 17).



Fig. 16: Item no. 14100502

2. Squeeze handles (Fig. 18).

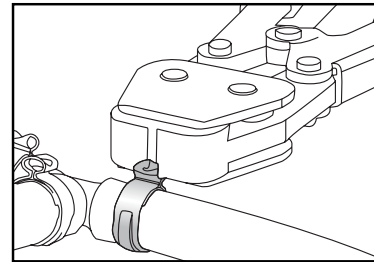

Fig. 17: Correct jaw tip placement

3. Cut through and remove clamp (Fig. 19)

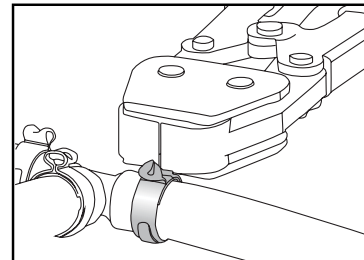

Fig. 18: Squeeze handles

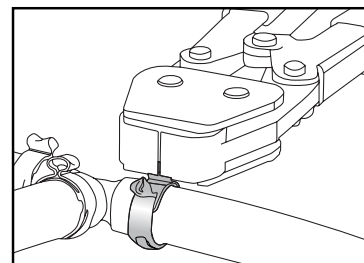

Fig. 19: Cut and remove clamp

NOTICE

- ▶ Caution must be observed with Hand Clamp Cutters, they can generate extreme forces.
- ▶ It is recommended that protective eye wear be worn when cutting clamps.